

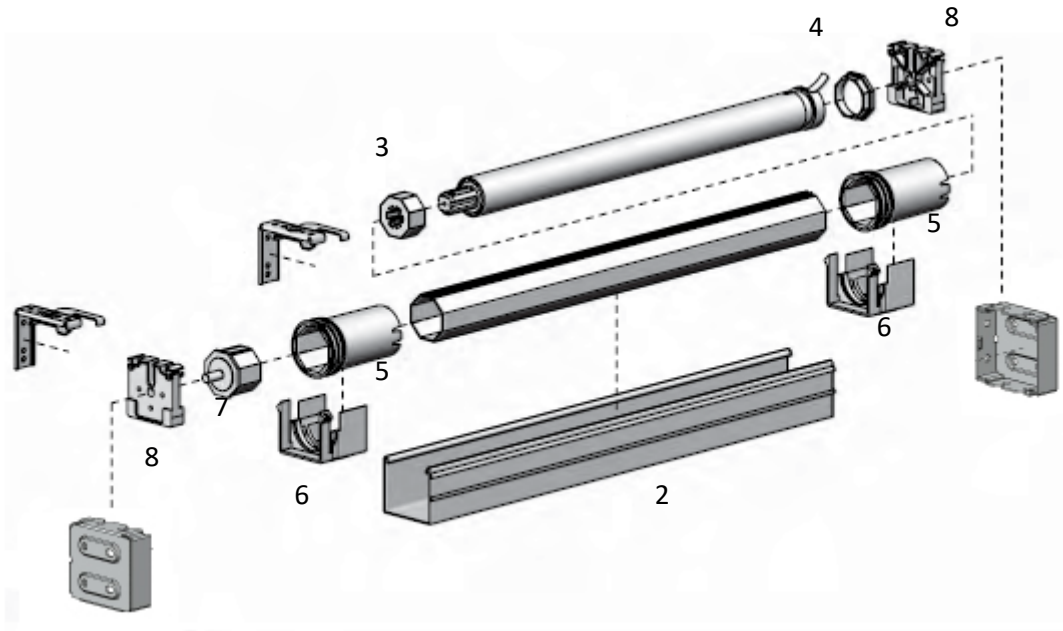



PH 50mm Motorizada



1		TUBO ALUM. CRUDE OCTOGONAL LISO 40mm P/ MOTORIZACAO 008.200.014.40.00	40 mm	6 m
2		PERFIL SUP. LISO 009.000.COR.00.07 008.001.COR.50.00	58 x 50mm – Aço 56 x 50mm – Alum.	5 m 6 m
3		ADAPTADOR DRIVE P/ TUBO OCT. 40mm 160.004.020.00.00 150.004.001.00.00	Somfy Tube	1 unid 1 unid
Usar com: TUBO ALUM. CRU OCTOGONAL LISO 40mm P/ MOTORIZACAO				
4		ADAPTADOR COROA P/ TUBO OCT 40mm 160.004.019.00.00 150.004.013.00.00	Somfy Tube	1 unid 1 unid
Usar com: Motor 35mm				
5		CONE P/ MOTORIZACAO PH50 160.004.021.00.00	Cone	1 unid
Usar com: TUBO ALUM. CRU OCTOGONAL LISO 40mm P/ MOTORIZACAO				

6		SUPOORTE PLAST. BLACK P/ CONE MOTORIZACAO PH50	160.002.007.00.00	Suporte	1 unid	Usar com: PERFIL SUP. LISO

7		PONTA OPOSTA P/ TUBO OCT. 40mm	160.004.018.00.00	Ponta Oposta	1 unid	Usar com: SUPORTE P/ MOTOR E PONTEIRA P/ CTS 40

8		SUPOORTE QUAD. BLACK P/ MOTOR/PONTA OPOSTA PH50	160.002.009.00.00	Suporte	1 unid	Usar com: PERFIL SUP. LISO

SUPOORTES E TAMPAS – Ver opções na página nº 143

CORDAS E CADARÇOS – Ver opções na página nº 144

LÂMINA, PERFIL INFERIOR, BANDÔ E ACESSÓRIOS – Ver opções na página nº 145

Motores Somfy 40mm

Consulte a linha completa de Motores Somfy na página nº 181
Dê preferência a motores lentos (< 20 RPM)

Emissores Somfy

Consulte a linha completa de Emissores Somfy na página nº 192







Motores Tube 35mm

Consulte a linha completa de Motores Tube na página nº 194
Dê preferência a motores lentos (< 20 RPM)

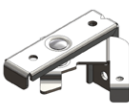

Emissores Tube

Consulte a linha completa de Emissores Tube na página nº 197

Suportes e Tampas

7		SUPORTE INSTAL. LATERAL P/ PH50	027.021.COR.00.25	Suporte	10 jogos	Usar com: PERFIL SUP. LISO
7		TAMPA PERFIL ACO SUP. P/ PH50	104.021.COR.00.23	Tampa	50 unid	Usar com: PERFIL SUP. LISO
9		SUPORTE INSTAL. L CRUDE C/ GARRA P/ PH50	104.050.000.00.00	Suporte	50 unid	Usar com: PERFIL SUP. LISO
9		SUPORTE INSTAL. L PAREDE CRUDE P/ PH50	027.022.001.00.00	Suporte	50 unid	Usar com: PERFIL SUP. LISO
9		SUPORTE INSTAL. RETO TETO CRUDE P/ PH50	027.022.000.00.01	Suporte	300 unid	Usar com: PERFIL SUP. LISO
10		SUPORTE INSTAL. CENTRAL P/ PH50	027.024.COR.00.02	Suporte	50 unid	Usar com: PERFIL SUP. LISO

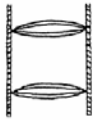
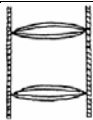
Cordas e Cadarços

12		CORDA		
		025.002.COR.12.45	1,2mm	1000 m
		025.005.COR.18.45	1,8mm	1000 m
		025.005.COR.20.45	2,0mm	500 m
13		CADARÇO P/ PHA 50mm 42x53mm		
		020.004.COR.50.45	P/ Alumínio	500 m
13		CADARÇO P/ PHM 50mm 44X54mm		
		020.005.COR.50.00	P/ Madeira	500 m
13		CINTA P/ PH50		
		020.006.COR.00.45	25mm – Várias Cores	50 m
		020.008.COR.00.45	35mm – Várias Cores	50 m
		020.010.COR.38.45	35mm – Print	50 m

Lâmina, Perfil Inferior, Bandô e Acessórios

PH Alumínio

LÂMINA ALUMÍNIO 50 x 0,21mm (PRÉ-CURVADA)



010.050.COR.50.40	Lisa	800 m
010.051.COR.50.40	Perfurada	800 m
010.050.WOO.50.40	Wood	800 m
010.050.FRI.50.40	Frizz	800 m

Ver opções de cores no mostruário de lâminas

PERFIL ALUM. INF. LISO P/ PH50



008.001.COR.00.00	Alumínio	6 m
009.005.COR.00.07	Aço	5 m

TAMPA PLAST. P/ PERFIL INF. PH50



104.022.COR.00.23	P/ Alumínio	100 unid
104.052.COR.00.23	P/ Aço	100 unid

Usar com: PERFIL ALUM. INF. LISO P/ PH 50mm

PERFIL INF. PVC DUPLO INCOLOR P/ PH50mm



009.213.005.00.11	Perfil Inferior	5 m
-------------------	-----------------	-----

TAMPA PERFIL INF. PVC DUPLO P/ PH50mm



104.041.COR.00.57	Tampa	100 unid
-------------------	-------	----------

Usar com: PERFIL INF. PVC DUPLO INCOLOR P/ PH50mm

BOTAO PLAST. P/ PH50



104.023.COR.00.23	Botão	100 unid
-------------------	-------	----------

Usar com: Cadarço

CLIP PLAST. FIXACAO 38mm P/ CINTA PH50

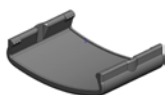

104.024.COR.00.23	Cinta Amarração	100 unid
-------------------	-----------------	----------

Usar com: Cinta

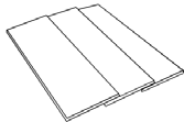
PH Madeira

LAM. MAD. BW 9ft (2,74m) P/ PHM50

011.014.COR.09.42

NATURAL

200 unid

ESPACADOR PLAST. P/ PHM50

104.030.060.00.00

Clip

100 unid

PERFIL INF. MAD. BW 9ft (2,74m) P/ PHM50

009.012.COR.09.42

NATURAL

24 unid

A foto pode não corresponder exatamente ao produto

BANDO MAD. BW 9ft (2,74m) P/ PHM50

104.004.COR.09.42

NATURAL

24 unid

A foto pode não corresponder exatamente ao produto

SUPORTE CRUDE P/ BANDO PHM50

027.031.001.00.00

Clip Bandô

100 unid

Usar com: Bando Madeira Natural