

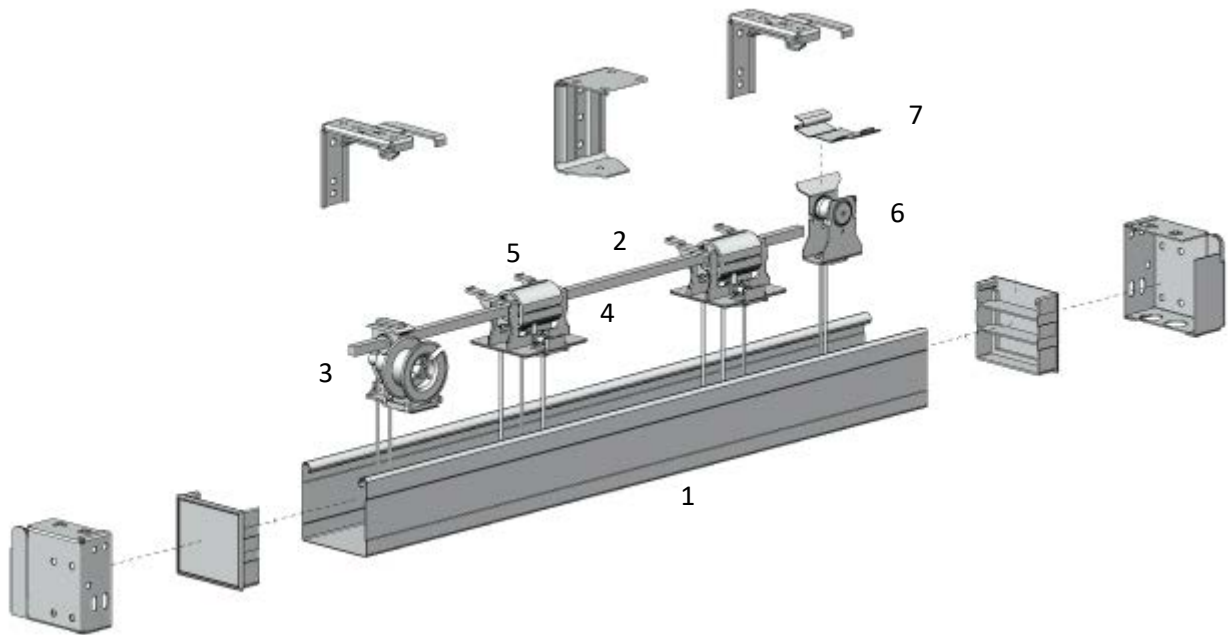

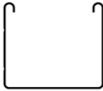







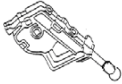
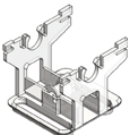

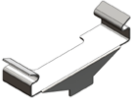
## PH 50mm Standard

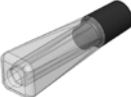

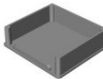
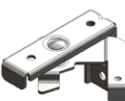

1		PERFIL SUP. LISO	009.000.COR.00.07	56 x 50mm – Aço	5 m
			008.001.COR.50.00	56 x 50mm – Alum	6 m
2		EIXO ALUM. QUAD. 6mm P/ PH50	008.100.007.06.00	Eixo	6 m
3		GIRATORIO METAL. CORDA EIXO QUAD. 6mm P/ PH50	104.009.000.00.00	Giratório Corda	50 unid
				Usar com: EIXO ALUM. CRU QUADRADO 6X6mm P/ 50mm	
3		GIRATORIO METAL. GANCHO EIXO QUAD. 6mm P/ PH50	104.044.000.00.00	Giratório Bastão	50 unid
				Usar com: EIXO ALUM. CRU QUADRADO 6X6mm P/ 50mm	
4		MANCAL CINTA/CADARCO P/ PH50	104.012.000.00.00	Mancal	50 unid
				Usar com: TAMBOR EIXO QUAD. 6mm P/ 50mm	

5		TAMBOR RDO. P/ EIXO QUAD. 6mm 50mm	104.018.000.00.00	Tambor	50 unid	Usar com: EIXO ALUM. CRU QUADRADO 6X6mm P/ 50mm
6		FREIO METAL CORDA P/ PH50	104.007.000.00.00	Freio	50 unid	Usar com: EIXO ALUM. CRU QUADRADO 6X6mm P/ 50mm
7		TERMINAL ENCAIXE P/ PH50	104.019.000.00.00	Terminal	50 unid	Usar com: PERFIL SUP. LISO
		ANEL DE BORRACHA P/ PH50	104.028.000.00.00	Anel	100 unid	Usar com: EIXO ALUM. CRU QUADRADO 6X6mm P/ 50mm
		PINGENTE ALUM. 35mm P/ PHM	104.004.COR.00.84	Alumínio	10 unid	Usar com: Corda 1,2mm
		PINGENTE TRANSP/WHITE P/ PH25/16	101.054.000.00.23	Pingente	100 unid	Usar com: Giratório corda
		CLIP METAL VEZINHO P/ TAMBOR RDO.	101.015.000.00.23	Clip	1000 unid	
SUPORTES E TAMPAS – Ver opções na página nº 143						
CORDAS E CADARÇOS – Ver opções na página nº 144						
LÂMINA, PERFIL INFERIOR, BANDÔ E ACESSÓRIOS – Ver opções na página nº 145						

## Suportes e Tampas

7		SUPORTE INSTAL. LATERAL P/ PH50	027.021.COR.00.25	Suporte	10 jogos	Usar com: PERFIL SUP. LISO
7		TAMPA PERFIL ACO SUP. P/ PH50	104.021.COR.00.23	Tampa	50 unid	Usar com: PERFIL SUP. LISO
9		SUPORTE INSTAL. L CRUDE C/ GARRA P/ PH50	104.050.000.00.00	Suporte	50 unid	Usar com: PERFIL SUP. LISO
9		SUPORTE INSTAL. L PAREDE CRUDE P/ PH50	027.022.001.00.00	Suporte	50 unid	Usar com: PERFIL SUP. LISO
9		SUPORTE INSTAL. RETO TETO CRUDE P/ PH50	027.022.000.00.01	Suporte	300 unid	Usar com: PERFIL SUP. LISO
10		SUPORTE INSTAL. CENTRAL P/ PH50	027.024.COR.00.02	Suporte	50 unid	Usar com: PERFIL SUP. LISO

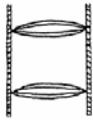
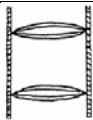
## Cordas e Cadarços

12		CORDA		
		025.002.COR.12.45	1,2mm	1000 m
		025.005.COR.18.45	1,8mm	1000 m
		025.005.COR.20.45	2,0mm	500 m
13		CADARÇO P/ PHA 50mm 42x53mm		
		020.004.COR.50.45	P/ Alumínio	500 m
13		CADARÇO P/ PHM 50mm 44X54mm		
		020.005.COR.50.00	P/ Madeira	500 m
13		CINTA P/ PH50		
		020.006.COR.00.45	25mm – Várias Cores	50 m
		020.008.COR.00.45	35mm – Várias Cores	50 m
		020.010.COR.38.45	35mm – Print	50 m

## Lâmina, Perfil Inferior, Bandô e Acessórios

### PH Alumínio

---

#### LÂMINA ALUMÍNIO 50 x 0,21mm (PRÉ-CURVADA)



010.050.COR.50.40	Lisa	800 m
010.051.COR.50.40	Perfurada	800 m
010.050.WOO.50.40	Wood	800 m
010.050.FRI.50.40	Frizz	800 m

Ver opções de cores no mostruário de lâminas

---

#### PERFIL ALUM. INF. LISO P/ PH50



008.001.COR.00.00	Alumínio	6 m
009.005.COR.00.07	Aço	5 m

---

#### TAMPA PLAST. P/ PERFIL INF. PH50



104.022.COR.00.23	P/ Alumínio	100 unid
104.052.COR.00.23	P/ Aço	100 unid

Usar com: PERFIL ALUM. INF. LISO P/ PH 50mm

---

#### PERFIL INF. PVC DUPLO INCOLOR P/ PH50mm



009.213.005.00.11	Perfil Inferior	5 m
-------------------	-----------------	-----

---

#### TAMPA PERFIL INF. PVC DUPLO P/ PH50mm



104.041.COR.00.57	Tampa	100 unid
-------------------	-------	----------

Usar com: PERFIL INF. PVC DUPLO INCOLOR P/ PH50mm

---

#### BOTAO PLAST. P/ PH50



104.023.COR.00.23	Botão	100 unid
-------------------	-------	----------

Usar com: Cadarço

---

#### CLIP PLAST. FIXACAO 38mm P/ CINTA PH50

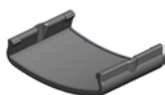

104.024.COR.00.23	Cinta Amarração	100 unid
-------------------	-----------------	----------

Usar com: Cinta

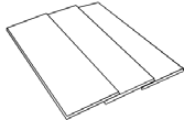
**PH Madeira**

**LAM. MAD. BW 9ft (2,74m) P/ PHM50**

011.014.COR.09.42

NATURAL

200 unid

**ESPACADOR PLAST. P/ PHM50**

104.030.060.00.00

Clip

100 unid

**PERFIL INF. MAD. BW 9ft (2,74m) P/ PHM50**

009.012.COR.09.42

NATURAL

24 unid

A foto pode não corresponder exatamente ao produto

**BANDO MAD. BW 9ft (2,74m) P/ PHM50**

104.004.COR.09.42

NATURAL

24 unid

A foto pode não corresponder exatamente ao produto

**SUPORTE CRUDE P/ BANDO PHM50**

027.031.001.00.00

Clip Bandô

100 unid

Usar com: Bando Madeira Natural